



bajadesigns[®]
THE SCIENTISTS OF LIGHTING

(23-On) Ford Super Duty Bull bar Kit

(44-8232, 44-8232-UP, 44-8233, 44-8233-UP, 44-8234, 44-8234-UP, 44-8235, 44-8235-UP, 44-8236, 44-8236-UP, 44-8237, 44-8237-UP)



2950 Norman Strasse San Marcos, CA 92069

Phone 760-560-2252 X3 • Fax 760-560-0383

info@bajadesigns.com • www.bajadesigns.com



baja designs[®]
THE SCIENTISTS OF LIGHTING

LIMITED LIFETIME WARRANTY

Baja Designs proudly offers a LIFETIME WARRANTY against manufacturer's defect on all the products that we manufacture.

These are comprehensive warranties; other than the exclusions below – you're covered. If your LED or HID bulb burns out, you're covered. Additionally, cutting off our connector or changing your lenses does not automatically void your warranty.

Exclusions:

Installation errors, abuse, misuse, or crash damage. You must be the original owner of the product and can supply proof of purchase.

Baja Designs manufactures its own products as well as resells products manufactured by others. Baja Designs makes no express or implied warranties on products not manufactured by Baja Designs including without limitation any warranties or merchantability and fitness for a purpose. We will, however, pass on all warranties made by the manufacturer, who has sole responsibility for performing such warranties.

Baja Designs will pay the freight if your product is less than 90 days old, otherwise defective products must be returned to Baja Designs, Inc., freight prepaid. At our option, we will repair or replace items in question and return them at no charge. If the identical product is no longer available, we will replace it with a similar product of equal value. Baja Designs Inc. will not be responsible for any indirect or consequential damages in connection with defective merchandise.

Items purchased through a Baja Designs authorized dealer must be returned through the dealer. Only available on LED auxiliary lights and product must be in sellable condition at MSRP. Product that has been damaged in any way after the original purchase date will be excluded from this guarantee.

Indemnification:

Buyer hereby acknowledges off-roading, racing and driving at night are dangerous activities and that the products and/or supplies purchased from Baja Designs are used in an inherently dangerous activity that may endanger life and limb; and in no event shall the seller, or seller's heirs and assigns, be held liable for consequential damages, nor shall seller's liability on any claim for damages arising out of or connected with the sale, delivery, or use of purchased products and/or supplies exceed the purchase price of the products and/or supplies.

Buyer is responsible for ensuring that it uses the products (and its vehicle) in accordance with all applicable laws, regulations, guidelines, and standards of care. Buyer acknowledges that some products may only be used when off-roading, and Buyer will comply with all vehicle and road safety guidelines. Buyer is solely responsible for (and will indemnify and hold Bestop harmless for) any claims, losses, damages, fines, fees, costs, or other amounts arising out of Buyer's non-compliance with these provisions.

****For a color copy of instructions, visit your vehicle specific application on BajaDesigns.com ****

Required Tool(s):

- | | | |
|-----------------------------------------------------------|--------------|-----------------------------------|
| • 7mm, 10mm, 13mm, 15mm, 17mm, 18mm, 7/16", 9/16" Sockets | Pic | Step Drill 3/4" bit or 29/64" bit |
| • 13mm, 17mm, 7/16", 9/16" Wrenches | Pliers | |
| • T20 Torx | Flush cutter | |
| • Trim Removal Tool | Fish tape | |
| • Sharp blade | Dremel tool | |

Parts List:

<p style="text-align: center;">Lights</p>  <p>Qty: 4 for LP9; or Qty 5 for LP6; or Qty 6 for LP4 or Qty 6 for XL</p>	
 <p style="text-align: center;">(QTY:1) Wiring Harness</p>	 <p style="text-align: center;">(20-1019) Hardware, 3/8"-16 Thread Size, 1-1/4" Long Qty: same as qty of lights</p>
<p style="text-align: center;">(44-8230) (QTY:1) Ford, Super Duty (23-On), Bull Bar</p> 	 <p style="text-align: center;">(20-1009) (QTY:2) Hardware, M10-1.5x25mm Long Bolt</p>
 <p style="text-align: center;">(20-1499) (QTY:2) Hardware, M10 x 1.5 mm Thread SS Nylon Insert Locknut</p>	 <p style="text-align: center;">(20-1024) (QTY:4) Hardware, 10mm Flat Washer</p>

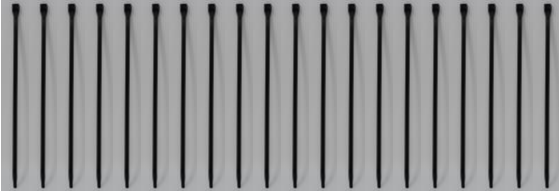

(20-1612) (QTY:20)
Hardware, Zip Tie 50lb 8"



(64-0156) (QTY:2")
Hardware, 0.070" Thick Sticky Back EPDM

To begin, make sure the vehicle is in park, on level ground and the parking brake is engaged.

Step 1: With a 10mm socket, disconnect the negative battery cable from both batteries (boxed) (some vehicles may have only one battery). Ensure the cables cannot touch either of the posts.

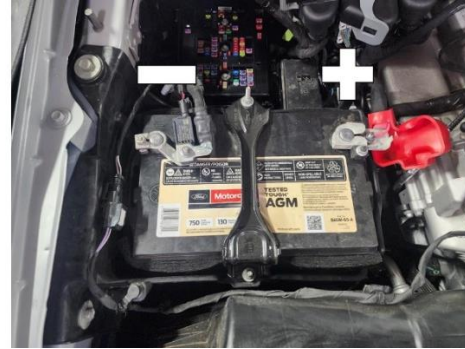

Step 2: From underneath the vehicle disconnect the OEM plug located on the Driver side frame rail next to the front bumper. This will allow the bumper to be removed.

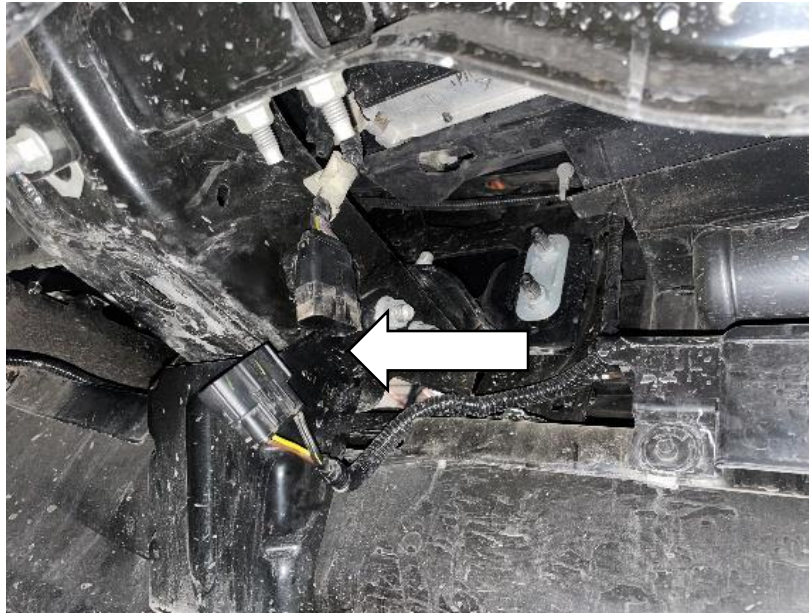

Step 3: Remove the 2X bolts connecting the bumper to the bumper support using a 15mm socket.

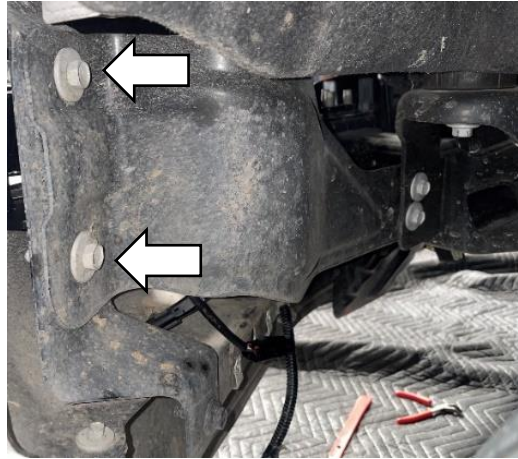

Step 4: Remove the plastic trim from around the tow hooks by pulling firmly from the tow hook opening and slipping a flat tool in the gaps indicated to separate the overlapping trim panels. (Both sides)



Step 5: Free the rubber trim from the OEM fastener (A) by using a trim removal tool to loosen the fastener and pry the rubber trim out from behind it. (Repeat steps 3-5 on both sides).

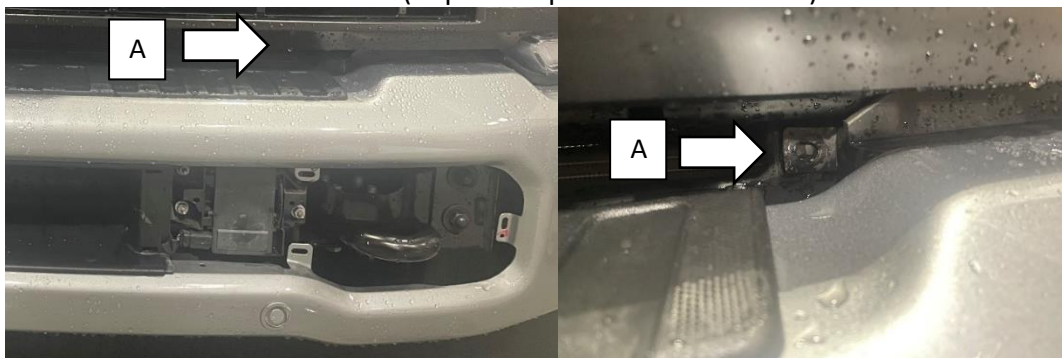

Step 6: (Only applicable for models equipped with Adaptive cruise control)

Pull the securing tab (B) to the right and remove the adaptive cruise module. Disconnect the connector (C) from the adaptive cruise module. Put the adaptive cruise module in a **VERY** safe place.

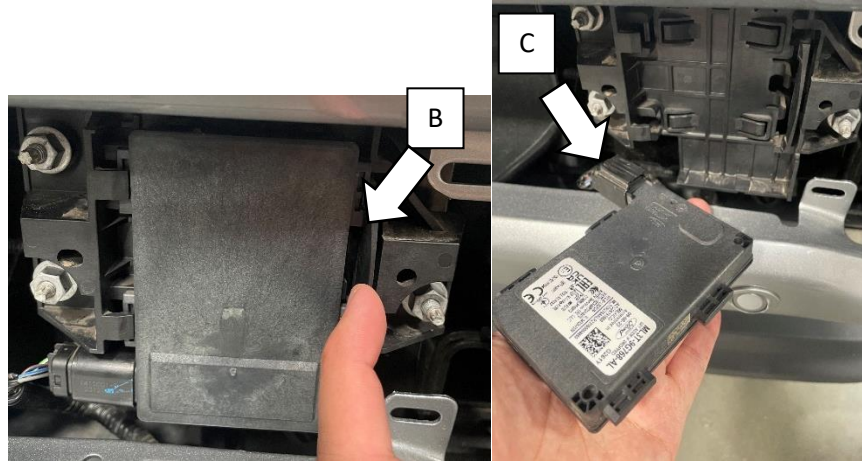

Step 7: Loosen the 3X nuts using a 7mm socket. Pull the plastic bracket straight out firmly to release it from the 3X studs.

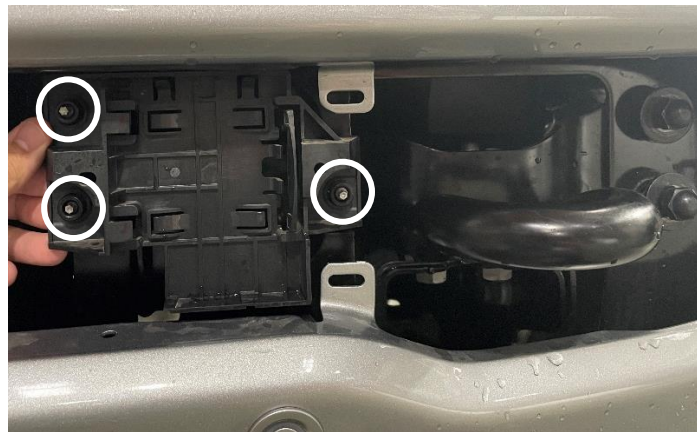

Step 8: Loosen 8X bolts from the front bumper mounts using an 18mm socket. **Recommended to use three people for this task. One person would go underneath the vehicle and remove the nut plate holding the bumper bolts from behind. While the person removes the bolts, two people must hold two corners of the bumper as it is heavy. Once the nuts are removed, remove the bumper and place it on a soft/flat surface.**



Step 9: Remove the plastic trim piece on top of the bumper. Use pliers to squeeze the clips from the inside and push them out. Remove any clips tying the panel to the harness. Cut the trim panel using a Dremel tool at the lines indicated. After trimming, install the trim piece back on the bumper (follow steps 5-8 in reverse) and **mount the bumper back on the chassis.** Only put back bolts numbered 5-8 (from step 8)



Step 10: Use the given proper template (at the end of instructions) to cut a section from the trim panels. Use a Dremel tool for the cutting and cleaning. Once the section is cut, the panel will slide in the bull bar mount. **Do this for both the plastic trim panels.**



Step 11: Place the modified plastic trim panels that were removed from the bumper on the lower bull bar mounts.



Step 12: Cut the provided EPDM strip (64-0156) into 4 sections using a sharp blade and apply two to each mount as shown below. Line up the straight edges and trim the excess as shown.

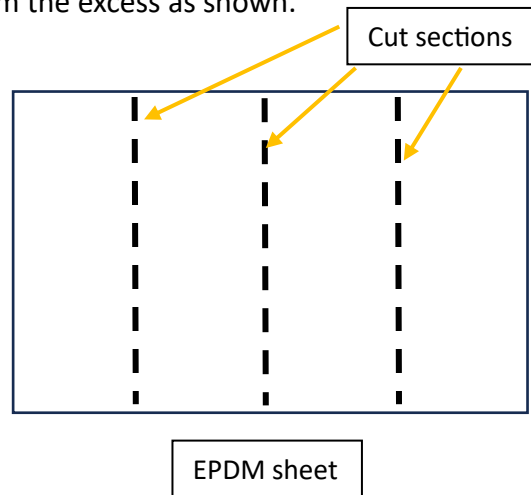

Step 13: Mount the bull Bar on the bumper. With 17mm socket, fasten the two provided M10 (20-1009) bolts on the top using provided M10 lock nuts (20-1499).



Use washers (20-1024) for the installation. The first washer goes between bolt and bull bar (on top) and the second washer goes between the lock nut and bumper. The lock nuts go from the bottom as shown in the image below.

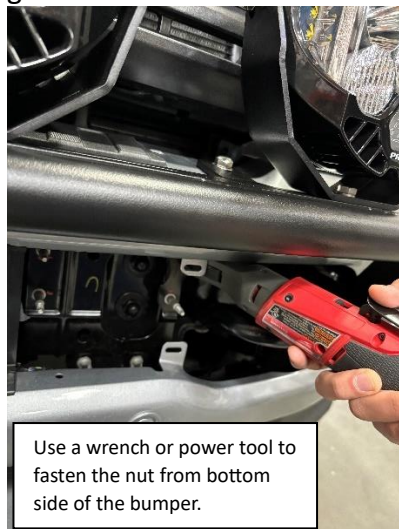

Use a wrench or power tool to fasten the nut from bottom side of the bumper.



Use the 4X OEM bumper bolts (bolts 1-4 from step 8) for the bottom mount using an 18mm socket.



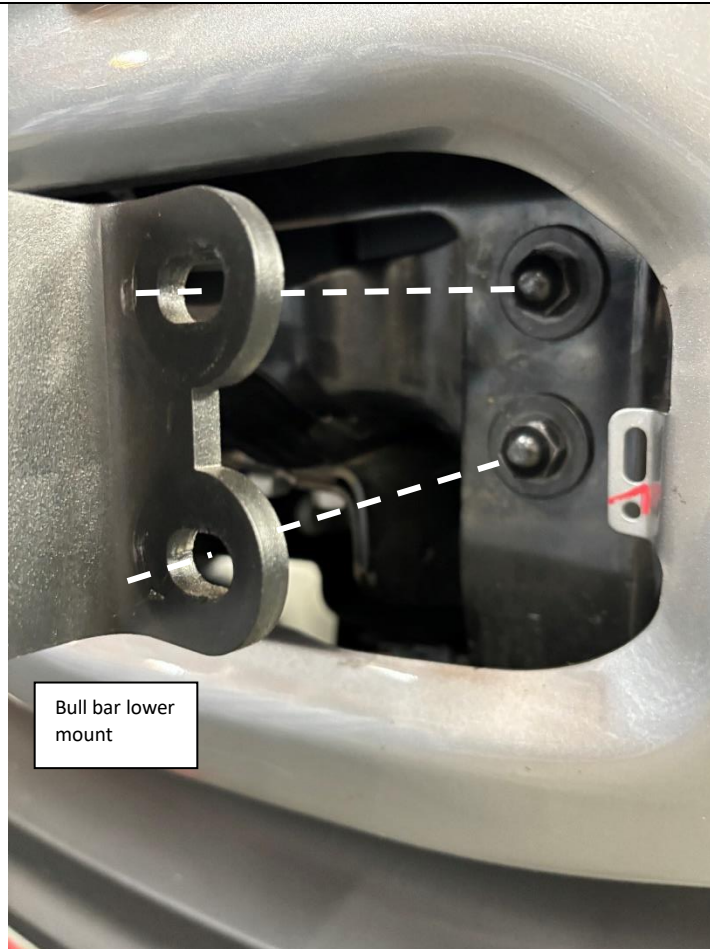

Bull bar lower mount

Step 14: After the bull bar is mounted back on the bumper, make sure the adaptive cruise bracket is reconnected. Reinstall the 3X nuts on that bracket. Push the modified plastic trim panels back into their location, make sure they “click” as the tabs engage.



Step 15: Run the connector leads of the wire harness down near the air intake. Route the harness the way it is shown in the photo on the right. Secure the loose wires.

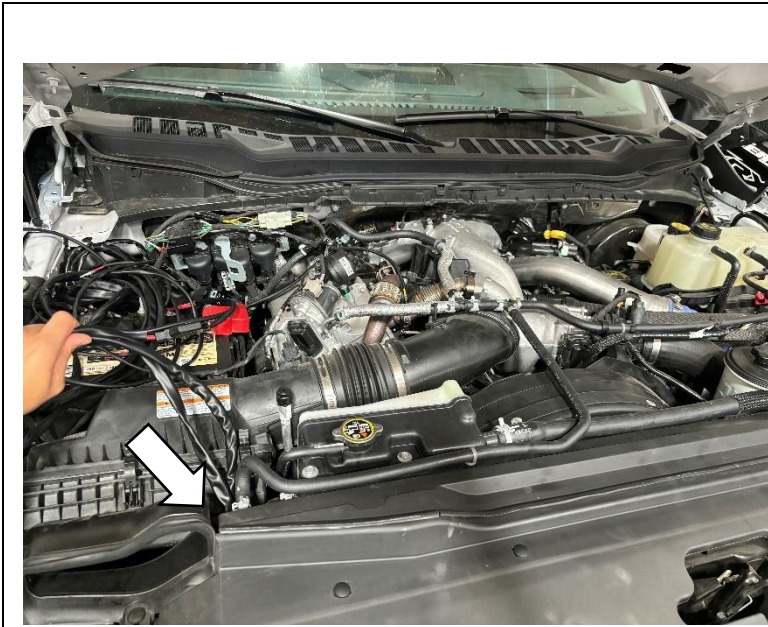

Step 16: Take out the harness from the front side of the bumper as shown. The harness is now ready to be connected to the lights which will be mounted on the bull bar.



Step 17: The lights need to be mounted in the slots provided on the bull bar. Use the image provided below for reference.

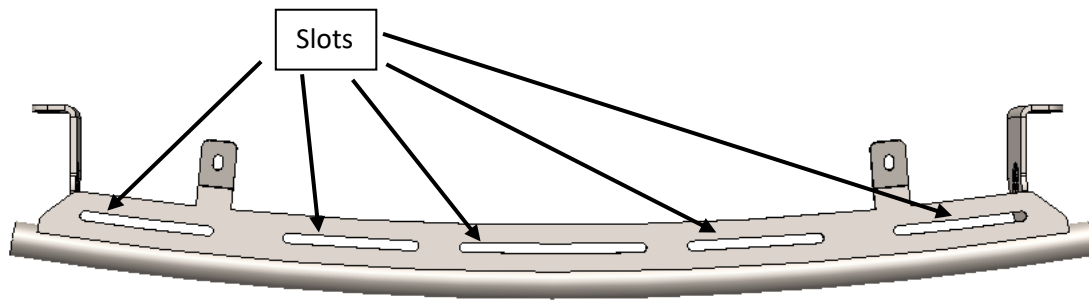

Find the included hardware bag and attach the light to the bracket using the 1/4-20" hex head bolt with washers using 7/16" socket. For mounting the light on the bull bar use the 3/8" bolt (20-1019, it is separate from the parts bag) for ease of install. For extra support use all the three bolts on the light mount.

LP4

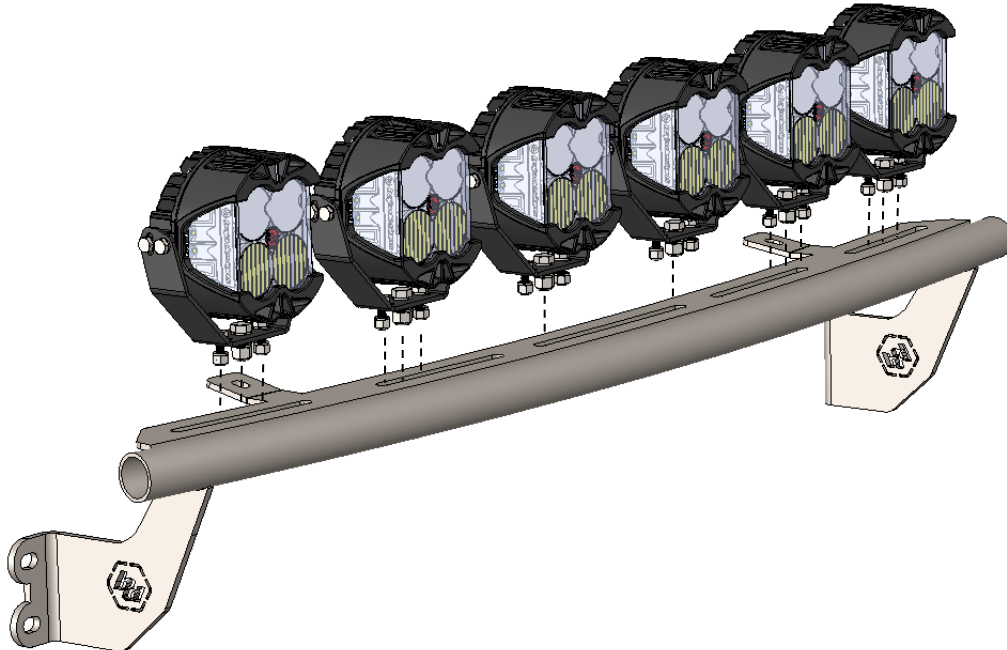

XL

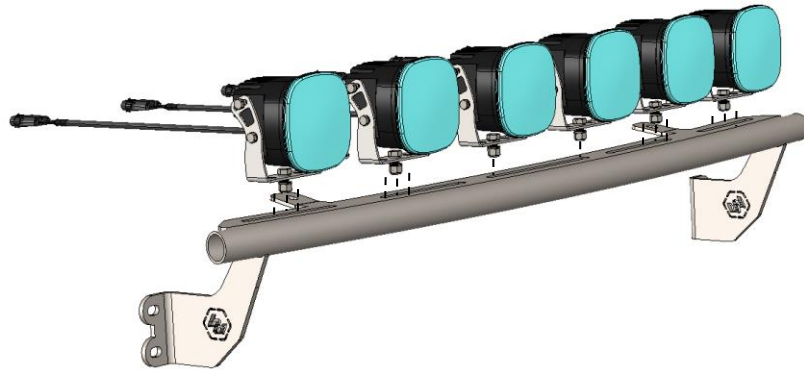

LP6

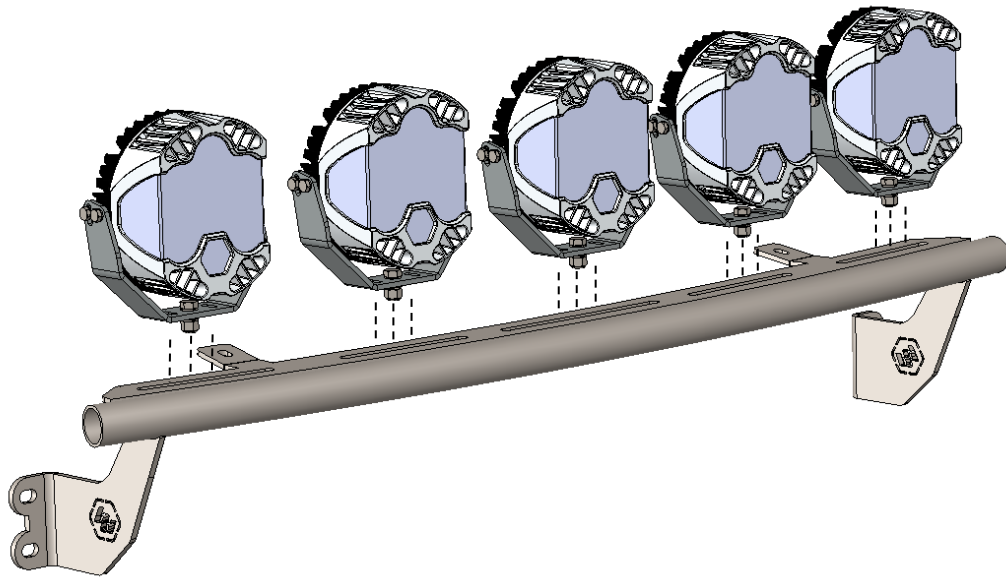

LP9

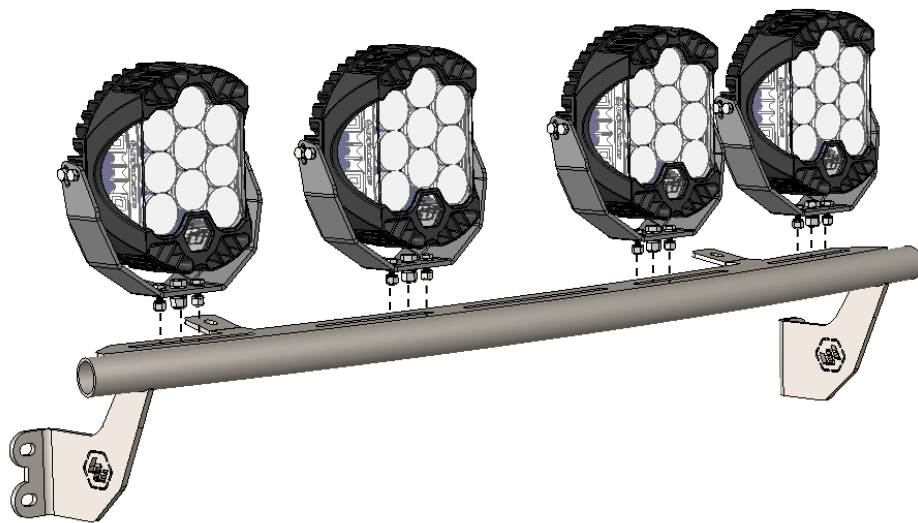

The following photo shows how to mount the bracket on to the light.
Example: LP4. (Same for LP6, LP9 and XL lights)

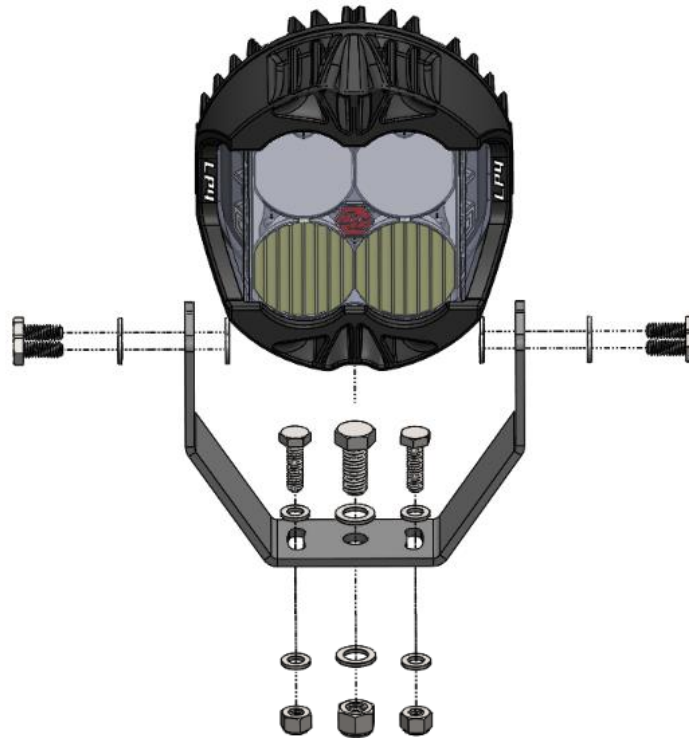

*For Backlight instructions go to Page 18.

Upfitter Only Locate and detach the upfitter fuse box located near the PS fuse box (boxed) by pressing in the two locking tabs (1&2) and lifting up to access the bundle of wires underneath it. Take the included upfitter wiring harness and attach the white wire scotchlok to the desired auxiliary wire using a set of pliers. Reinstall the upfitter fuse box. Attach the connectors on the upfitter harness to the lights mounted on the bull bar. Secure the relay where convenient.

[If the light has high beam low beam functionality (LP9/LP6), then the White wire lead is for high beam and Red wire lead is for low beam].

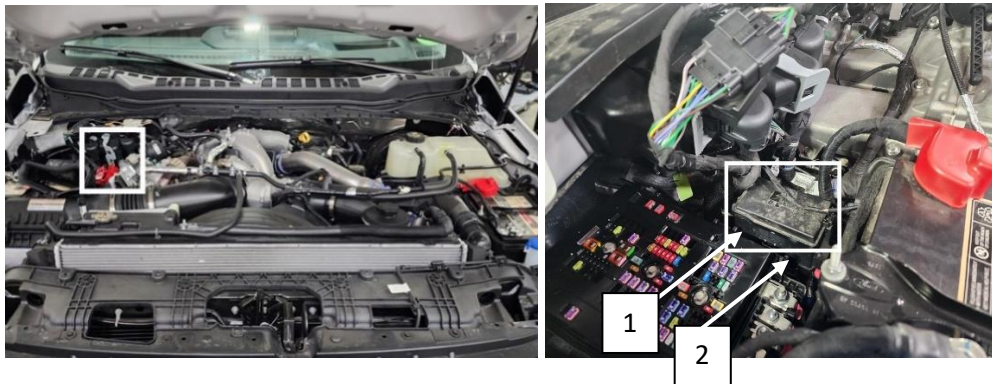

Aux Switch	Wire Color	Amp Rating
Aux 1	Bn/Gn	25
Aux 2	Vt/Og	25
Aux 3	Bu/Gn	25
Aux 4	Gy/Bn	25
Aux 5	Bn/Ye	40
Aux 6	Gy/Og	40

Skip this step if adding backlight

With the 10mm socket, attach the red ring terminal to the positive post and black ring terminal to the negative post of the battery/batteries. Place any excess wire into a service loop and secure it out of the way. The installation is now complete.



Toggle Switch Only

Run the switch lead across the firewall. Secure the relay where convenient. Zip tie the harness out of the way.



Based on the lights, the harness would either have a 3-position toggle switch or an On-Off round switch.

For XL/LP4 (On-Off switch)

Locate the white connector (D) that attaches the switch to the main harness and disconnect it. With a pick, remove the wire terminals from the connector. Run the switch lead, terminals first, through the wire passthrough located in the drivers footwell (circled) from inside the cab. Pull the cable through once you are past the grommet and up to your main harness. Reinstall the terminals into the connector and reattach it to the main harness.

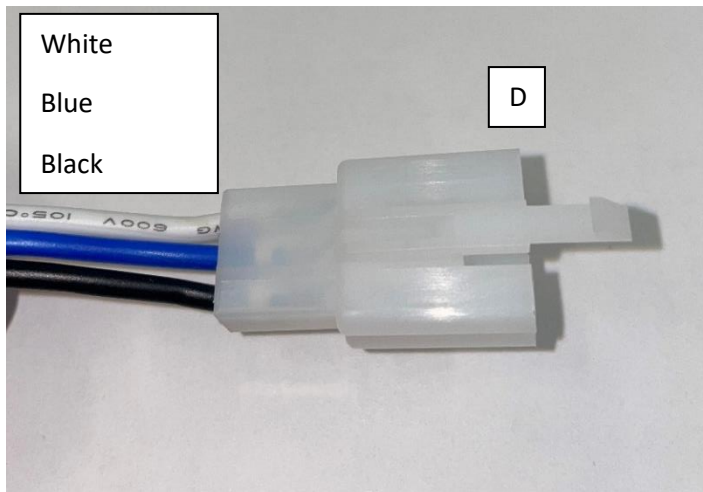

For LP9/LP6 (Toggle switch)

Take a photo of the wires running from the switch for reference. Use a pick to remove the wire terminals from the switch. Make a hole in the grommet (on the passthrough in the picture). Use fish tape and push it through the passthrough from the driver's footwell. Pull the fish tape from the engine bay side. Use electrical tape to tie the harness (terminals) to it. Once the harness is tightly attached to the fish tape pull it from inside the cab. Leave the switch unattached for now.

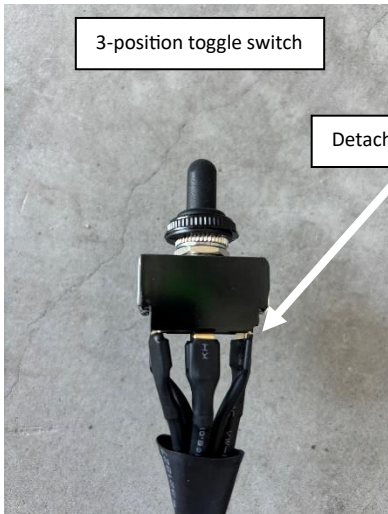

3-position toggle switch

Detach wires from here



Remove the bezel from around the vent by prying at the edges and pulling directly backwards. Locate the panel on the side of the dash and remove the door seal around it. Gently pull outwards on the panel to remove it.

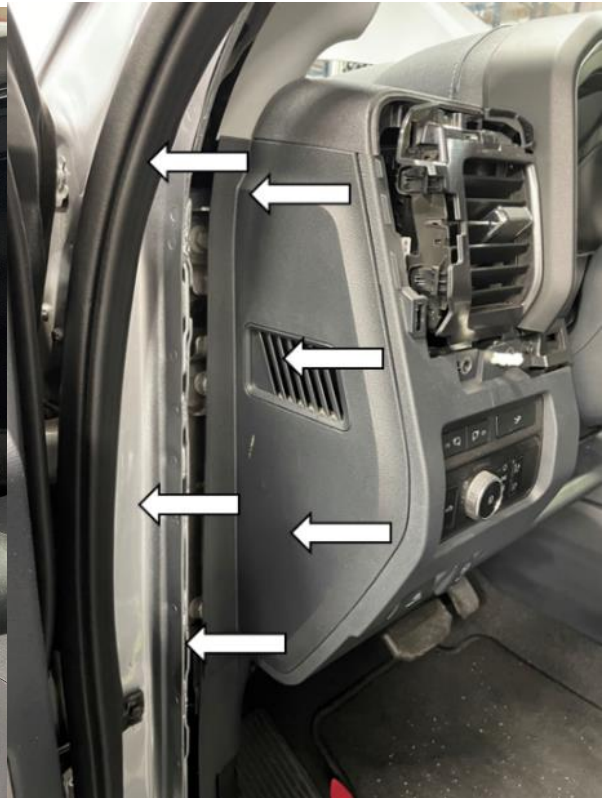

With a T20 Torx (boxed) and 7mm socket (triangle), remove the 3 screws securing the trim panel surrounding the headlight controls. Gently pull the panel diagonally downward (E) to allow access behind it. Check for clearance behind the panel and drill a hole at the recommended switch location. For round switch option make a $\frac{3}{4}$ " hole. For the 3-position toggle switch option make a $\frac{29}{64}$ " hole.

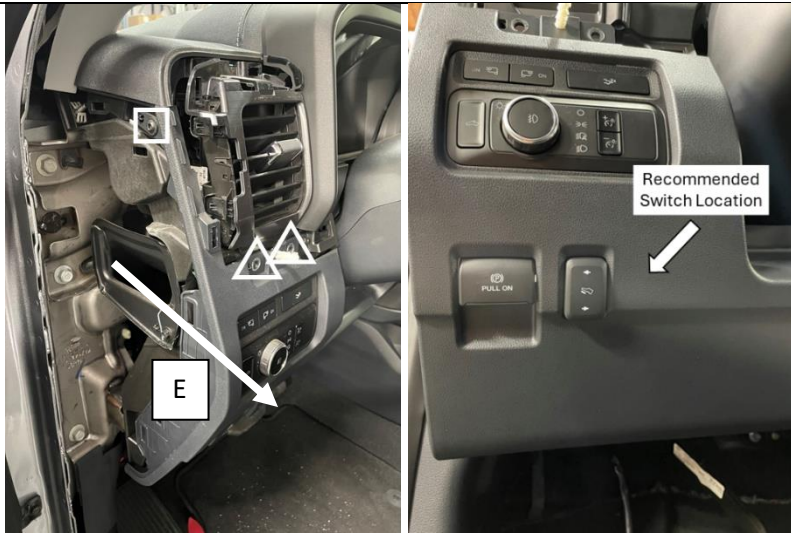

*For Backlight instructions go to Page 18.

For XL/LP4

Disconnect the spade connectors and run the wires through the newly created switch hole. Reconnect the wires and press the switch into place. Reinstall all the interior trim panels.

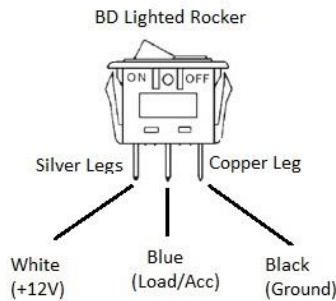

For LP9/LP6

Reconnect the wires to the switch first and detach the toggle pin cover. Run the switch through the newly created switch hole till the toggle pin comes out. Fasten the toggle pin cover from outside to fix the switch in its position.



Reinstall all the interior trim panels.

Skip this step if adding backlight

With the 10mm socket, attach the red ring terminal to the positive post and black ring terminal to the negative post of the battery/batteries. Place any excess wire into a service loop and secure it out of the way. The installation is now complete.

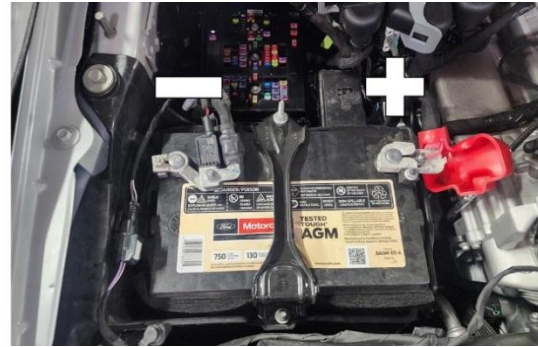

Backlight Instructions for LP9/LP6/LP4

1. Remove the core support cover by removing the plastic push rivets (1st photo). With a 10mm socket, remove the 4 bolts and 2 plastic push rivets on the top of the grill (2nd photo). Remove the small plastic covers on the lower grill (3rd photo) to expose the two lower bolts and remove with a 10mm socket (use an extension).

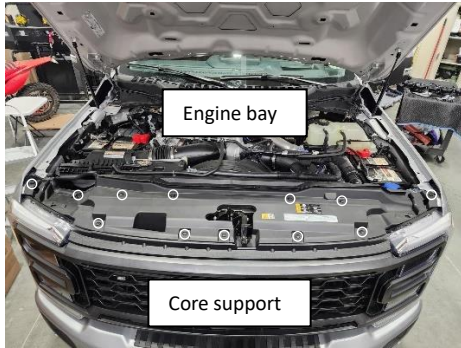

2. Carefully pull the front grill out disengaging the plastic clips. Remove the electrical connector and water line from the grill to free it. To remove the water line, remove the small black plastic ring and pull.

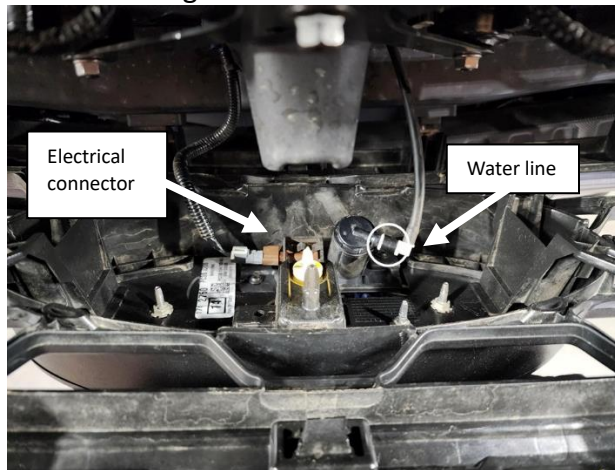

Remove the 2x 10mm bolts from the top of the DS headlight and the 13mm from the bottom by accessing it from the fender well. Pull the headlight out and remove the electrical connectors on the back. Find the included backlight wiring harness and locate the scotchlok connector. For trucks with stock LED headlights, place the scotchlok connector around the wire coming from Pin 8. For trucks with halogen bulbs, place the scotchlok around the Pin 2 wire of the two-pin connector.



Replace all removed panels in the opposite order of removal. With the 10mm socket, attach the red ring terminal to the positive post and black ring terminal to the negative post of the battery/batteries. Place any excess wire into a service loop and secure it out of the way. The installation is now complete.

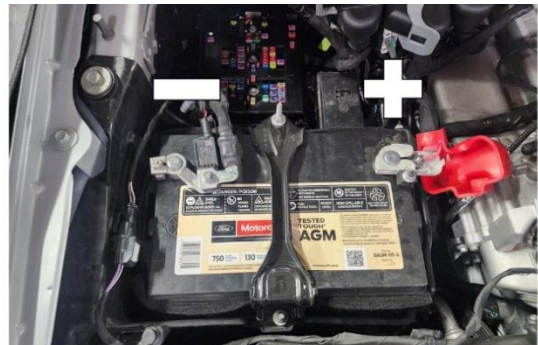

*Tie all wires away from sharp, hot, and/or rotating components.

* Re-torque all the fasteners after 100 miles.

*Your install is now complete! Thank you for choosing Baja Designs.

Template for step 10

PASSENGER SIDE

DRIVER SIDE

1.10

3.87

4.83

2.58

PLEASE USE 100% SCALE

For reference

1.00

*All dimensions are in inches

